

# PRESSURE SWITCHES

	DESCRIPTION	PRESSURE RANGE bar	CONNECTION thread	DEVICE	PAGE
<b>PRESSURE</b>	miniature, low cost	0.2 ... 2 / 200	G $\frac{1}{8}$ and G $\frac{1}{4}$	DS08 ... DS46	<b>12.02</b>
	many variations	0.1 ... 1 / 200	G $\frac{1}{8}$ m and G $\frac{1}{4}$ m	DS16 ... DS18	<b>12.03</b>
	low pressure, handwheel	0.005 ... 0.02 / 12	G $\frac{1}{8}$ m and G $\frac{1}{4}$ m	DSP	<b>12.05</b>
	low pressure, plastic	0.003 ... 0.03 / 7	$\frac{1}{8}$ "NPT m	F4200	<b>12.06</b>
	small hysteresis	0.014 ... 0.14 / 7	$\frac{1}{8}$ "NPT m	F4300	<b>12.07</b>
	high accuracy	0.004 ... 0.012 / 0.15	nipple	F4000	www*
	for PCB	0.014 ... 0.14 / 7	nipple	F4400	www*
<b>VACUUM</b>	many options	-0.2 ... -1	G $\frac{1}{8}$	DS15	<b>12.03</b>
	with handwheel	-0.005... -0.02 / -0.7	G $\frac{1}{8}$ m and G $\frac{1}{4}$ m	DSP-V	<b>12.05</b>
	plastic	-0.001... -0.01 / -1	$\frac{1}{8}$ "NPTm	F4200-X	<b>12.06</b>
	also flangable	-0.007... -0.17 / -1	$\frac{1}{8}$ "NPTm	F4300-X	<b>12.07</b>
	with adjustable hysteresis	-0.007... -0.38 / -0.5	nipple	F4000-X	www*
	with small hysteresis	-0.007... -0.17 / -1	nipple	F4400-X	www*
<b>DIFFERENTIAL PRESS.</b>	with handwheel	5 ... 20 / 50 mbar	nipple	DSP-W	<b>12.05</b>
<b>ATEX</b>	dust, EXII 3D IP65 T90	0.3 ... 1.5 / 150	G $\frac{1}{4}$ male	DS34	<b>12.04</b>
	gas, EXII 2G ExdII C T6	1 ... 6 / 400	G $\frac{1}{4}$ female	DS35	<b>12.04</b>
	gas, EXII 2G Ex ia T4	0.005 ... 0.02 / 12	G $\frac{1}{8}$ m and G $\frac{1}{4}$ m	DSP	<b>12.05</b>
<b>PNEUMAT. SIGNAL</b>	pressure	0.07 ... 0.35 / 7	$\frac{1}{8}$ "NPTm	PP700/PP701	<b>12.08</b>
	vacuum	-0.03 ... 0.17 / -0.85	$\frac{1}{8}$ "NPTm	VP700/VP701	<b>12.08</b>
<b>ELECTRICAL SIGNAL</b>	with pressure indicator	-1 ... 1 / 10	G $\frac{1}{8}$ m	DSB/DSC	<b>12.10</b>
<b>STAINLESS STEEL</b>	many options	0.3 ... 1.5 / 200	G $\frac{1}{4}$ m	DS18	<b>12.03</b>
	low pressure, handwheel	0.005 ... 0.02 / 12	G $\frac{1}{8}$ m and G $\frac{1}{4}$ m	DSP	<b>12.05</b>



# 12

**Description** The small-sized pressure switch closes or opens an electrical contact when the desired pressure is reached. If it falls below, the contact will be reset.

**Media** DS10: compressed air DS13: compressed air and water All others: compressed air, water hydraulic oil

**Burst pressure** min. 20 bar, DS13: max. 15 bar, DS40C/D: max. 250 bar

**Contact** silver-coated, max. 2A Ohm resistive load, max. 100 VA

**Hysteresis** < 10% FS, DS10 and D40: 10 ... 15% FS

**Mounting position** any

**Life span** 10<sup>6</sup> operating cycle for max. 200 switches / min

**Protection class** IP 00, with protective cap IP 65

**Tolerance** ± 0.2 bar at 0.2 ... 2 bar, ± 0.5 bar at 1 ... 10 bar  
± 3 bar at 10 ... 70 bar, ± 5 bar at 50 ... 200 bar

**Electrical connection** contact pin 2 x 6.3 x 0.8 except for DS10 and DS40: screwed connection M2

**Temperature range** -25 °C to 85 °C / -13 °F to 185 °F DS13: -20 °C bis 75 °C / -4 °F to 167 °F

**Material** Body: brass for DS08, DS14, DS46  
steel for DS25, DS40  
plastic for DS13  
Elastomer: NBR/Buna-N, optionally EPDM, FKM and Kalrez

**Voltage** 42 V

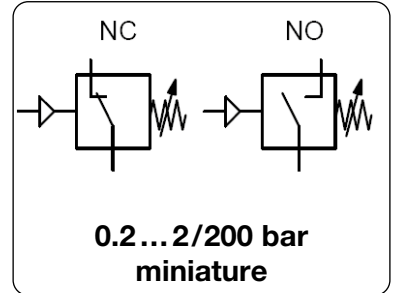

Switches



Dimensions			Body	Electr.	Connection	Pressure	Measurement	Order number	
A/F	B	C	made	connection	thread	transmission	range	contact	contact
mm	mm	mm	of		G	by	bar	NO	NC

Mini-Pressure switch, 42 V								NBR/Buna-N	DS	
17	13	22	brass	flat plug	G $\frac{1}{4}$	diaphragm	0.3 ... 1.0	2	DS08-21A	DS08-20A
								10	DS08-21B	DS08-20B
19	16	25	brass	screw connection	G $\frac{1}{8}$	diaphragm	1.0 ... 10		DS10-11B	
14	23	37	plastic	flat plug	G $\frac{1}{8}$	diaphragm	0.2 ... 1.0	2	DS13-11A	DS13-10A
								8	DS13-11B	DS13-10B
19	21	34	brass	flat plug	G $\frac{1}{8}$	diaphragm	0.3 ... 1.0	2	DS14-11A	DS14-10A
								10	DS14-11B	DS14-10B
24	20	34	steel	flat plug	G $\frac{1}{8}$	diaphragm	0.2 ... 1.0	2	DS25-11A	DS25-10A
								10	DS25-11B	DS25-10B
24	22	31	steel	screw connection	G $\frac{1}{8}$	diaphragm	0.3 ... 1.0	2	DS40-11A	DS40-10A
		37				diaphragm		10	DS40-11B	DS40-10B
						piston	10 ... 70		DS40-11C	DS40-10C
						piston	50 ... 200		DS40-11D	DS40-10D
27	29	35	brass	flat plug	G $\frac{1}{4}$	diaphragm	0.2 ... 0.5	2	DS46-21A	DS46-20A
								10	DS46-21B	DS46-20B



**Special options, add the appropriate letter**

G $\frac{1}{4}$ male connection thread	only for DS10 to DS40	DS...-2..
FKM elastomer for diaphragm	not for DS13	DS...-...V
	only for DS40 (C/D)	DS...-...V
EPDM elastomer for piston	only for DS10 and DS40	DS...-...E
Kalrez elastomer	only for DS10 and DS40	DS...-...K
gold contact	not for DS08	DS...-...G

**Accessories, enclosed**

protection cap	for DS10 <b>K210</b>	for DS08, DS13 and DS14 <b>K214</b>
	for DS25 <b>K250</b>	for DS40 and DS46 <b>K400</b>

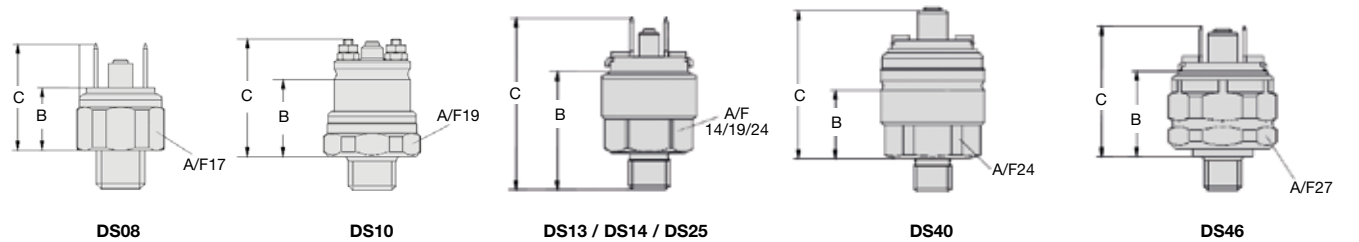

\* Product group

# PRESSURE SWITCH, UP TO 600 MBAR

## DS16 ... DS18

<b>Description</b>	The pressure switch closes or opens an electrical contact when the desired pressure is reached. If it falls below, the contact will be reset.		
<b>Media</b>	compressed air, non-corrosive gases or liquids		
<b>Overpressure</b>	see chart for max. static pressure, dynamic pressures are 50% lower		
<b>Switch contact</b>	DS16: NO contact, optionally NC contact	DS17/18: SPDT switch	
<b>Contact load</b>	DS16: 2 A at 42 V DC,	DS17: 4 A at 42 V DC,	DS18: 4 A at 250 V AC
<b>Electrical connector</b>	DS16: screw terminal,	DS17/18: spade terminal 6.3 x 0.8 mm, optionally also for 16	
<b>Hysteresis</b>	DS16: 5...20%,	DS17/18: adjustable to 10...30% by factory	
<b>Life cycle</b>	10 <sup>6</sup> switching cycles at < 50 bar	<b>Switching frequency</b>	max. 200 cycles/min
<b>Vibration resistance</b>	10 g at 5...200 Hz	<b>Shock resistance</b>	30 g
<b>Certifications</b>	CSA-certified and UL-listed		
<b>Protection class</b>	IP 00, with coupling socket IP 65		
<b>Temperature range</b>	-30 °C to 100 °C / -22 °F to 212 °F for NBR/Buna-N, -30 °C to 120 °C / -22 °F to 248 °F for EPDM, -5 °C to 120 °C / 23 °F to 248 °F for FKM		
<b>Material</b>	Body: steel, optionally stainless steel at DS18 Elastomer: NBR/Buna-N, optionally EPDM or FKM		

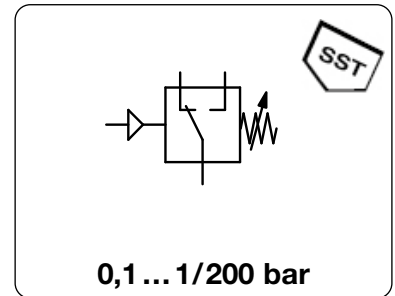

Switches



12

Pressure transmission by	Overpressure protection < bar	Measuring tolerance ± bar	Measurement range bar	Order number
--------------------------	-------------------------------	---------------------------	-----------------------	--------------

Pressure switch G1/4m, NO 42V	steel, NBR/Buna-N, without protective cap	DS16		
diaphragm	300	0.2	0.1 ... 1.0	DS16-A
		0.5	1.0 ... 10	DS16-B
		1.0	10 ... 20	DS16-C
		2.0	20 ... 50	DS16-D
piston	600	5.0	50 ... 150	DS16-E



DS16

Pressure switch G1/4m, SPDT 42V	steel, NBR/Buna-N, with coupling socket	DS17		
diaphragm	100	0.2	0.3 ... 1.5	DS17-A
	100	0.5	1.0 ... 10	DS17-B
	300	1.0	1.0 ... 10	DS17-C
	300	3.0	10 ... 50	DS17-D
	300	5.0	10 ... 100	DS17-E
piston	600	5.0	50 ... 200	DS17-H



DS17

Pressure switch G1/4m, SPDT 250V	steel, NBR/Buna-N, with coupling socket	DS18		
diaphragm	100	0.2	0.3 ... 1.5	DS18-A
	300	1.0	1.0 ... 10	DS18-C
	300	3.0	10 ... 50	DS18-D
	300	5.0	10 ... 100	DS18-E
piston	600	5.0	50 ... 200	DS18-H



DS18

### Special options, add the appropriate letter

<b>EPDM elastomer</b>		DS1-.E
<b>FKM elastomer</b>		DS1-.V
<b>free of oil and grease</b>	suitable for oxygen, max. 10 bar	DS1-.L
<b>NC contact</b>	instead of normally open contact	for DS16 DS1-.1
<b>spade terminal</b>	6.3 x 0.8 mm, galvanised	for DS16 DS1-.T
<b>600 bar overpressure</b>	maximum	for DS16 DS16-.U
<b>gold contact</b>	max. 24 V AC/DC, 50 mA	for DS17 DS17-.G
<b>250 V</b>	max. voltage	for DS17 DS17-.W
<b>stainless steel body</b>	0.5...5/200 bar	for DS18 DS18-.S
<b>factory-set pressure</b>	pressure indication falling pressure VF .. rising pressure	DS1-.VS..

### Accessories, enclosed

<b>protection cap</b>	straight, IP65	for DS16	DS16-KAP
-----------------------	----------------	----------	----------

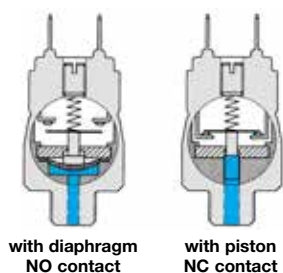
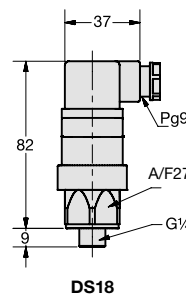
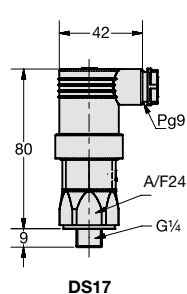
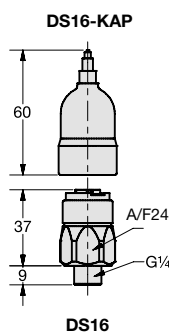

\* Product group

PDF CAD  
www.aircom.net



Order example:  
DS16-A

<b>Description</b>	The pressure switch closes or opens an electrical contact when the desired pressure is reached. When the pressure falls below the adjusted setpoint, the contact will be reset.	
<b>Media</b>	compressed air or non-corrosive gases	
<b>Overpressure</b>	see chart for max. static pressure,	
<b>Contact load</b>	DS34: 1 A at 230 V AC,	<b>Switch contact</b> SPDT switch
<b>ATEX version</b>	DS34: II 3D IP 65 T90°C	dynamic pressures are 50% lower
<b>Electrical connector</b>	DS34: 3-wire connection cable, length 2 m, cross-sectional area 0.75 mm <sup>2</sup> at DS34 or 0.5 mm <sup>2</sup> at DS35	DS35: 2 A at 230 V AC
<b>Hysteresis</b>	< 25% FS, ca. 10% FS in the lower range	DS35: II 2G Ex d II C T6/T5
<b>Life cycle</b>	10 <sup>8</sup> switching cycles at < 50 bar	<b>Switching frequency</b> 200 cycles/min
<b>Vibration resistance</b>	10 g at 5...200 Hz	<b>Shock resistance</b> 30 g
<b>Mounting position</b>	any	<b>Protection class</b> IP 65
<b>Temperature range</b>	-20 °C to 80 °C / 23 °F to 176 °F for NBR/Buna-N and EPDM	
<b>Material</b>	Body: zinc-plated steel at DS34, aluminium at DS35	
	Elastomer: NBR/Buna-N, optionally EPDM or FKM	

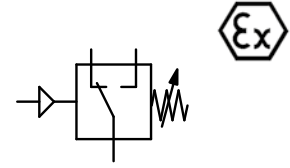

**0.3... 1.5/400 bar  
dust- and gas-proof**

Pressure transmission by	Overpressure protection < bar	Measurement tolerance ± bar	Measurement range bar	Order number
--------------------------	-------------------------------	-----------------------------	-----------------------	--------------

**Pressure switch G<sup>1</sup>/<sub>4</sub> male SPDT switch 230 V AC, 1A dust-proof II 3D IP 65 T90°C DS34**

diaphragm	300	0.2	0.3 ... 1.5	<b>DS34-A</b>
		0.5 - 1.0	1.0 ... 10	<b>DS34-B</b>
		1.0	10 ... 20	<b>DS34-C</b>
		2.0	20 ... 50	<b>DS34-D</b>
piston	600	5.0	50 ... 150	<b>DS34-E</b>



**DS34  
dust protection**

**Pressure switch G<sup>1</sup>/<sub>4</sub> female SPDT switch 230 V AC, 1A gas-proof II 2G Ex d II C T6/T5 DS35**

diaphragm	200	0.5	1 ... 6	<b>DS35-B</b>
		3.0	5 ... 50	<b>DS35-D</b>
piston	600	3 - 5	20 ... 100	<b>DS35-E</b>
		5 - 7	25 ... 250	<b>DS35-H</b>
		5 - 9	100 ... 400	<b>DS35-K</b>



**DS35  
gas protection**

**Special options, add the appropriate letter**

<b>EPDM elastomer</b>	-20 °C to 80 °C / -4 °F to 176 °F	DS3. - .E
<b>FKM elastomer</b>	- 5 °C to 80 °C / 23 °F to 176 °F	DS3. - .V
<b>free of oil and grease</b>	suitable for oxygen, max. 10 bar, diaphragm version only	DS3. - .L
<b>adjusted switchpoint</b>	± 5%, indicate on order	DS3. - .X

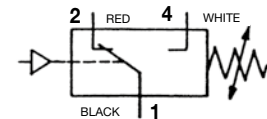
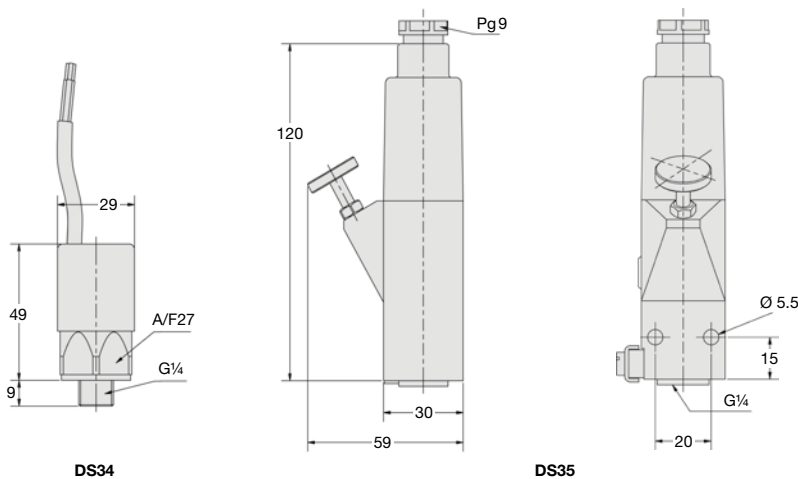

**pin configuration DS34**

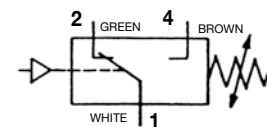

**pin configuration DS35**

\* Product group

PDF CAD  
www.aircom.net



**Order example:  
DS34-A**



<b>Description</b>	Adjustable pressure switch for monitoring pressure, vacuum and differential pressure. From the 6 bar device on two turns of the adjusting knob are necessary for the whole adjustment range, so the scale on the knob is inappropriate.		
<b>Media</b>	compressed air, non-corrosive gases or liquids	<b>Overpressure</b>	see chart
<b>Switch contact</b>	SPDT switch with silver contact, optionally gold contact		
<b>Contact load</b>	2 A at 24 V DC, 6 A at 250 V AC		
<b>Electrical connector</b>	AMP spade terminal, 6.3 x 8 mm, according to DIN 46244	<b>Hysteresis</b>	see chart
<b>Life cycle</b>	10 <sup>6</sup> switching cycles	<b>Vibration resistance</b>	20 g
<b>Certifications</b>	VDE, TÜV design test, optionally Atex	<b>Switching time</b>	30 ms
<b>Mounting position</b>	any, but indication needed for switch point < 100 mbar	<b>Protection class</b>	IP 65 w/ coupling socket
<b>Temperature range</b>	-20 °C to 85 °C / -4 °F to 185 °F for NBR/Buna-N, EPDM and polyamide, up to 130 °C / 266 °F for FKM		
<b>Material</b>	Body: Zytel, a high-quality polyamide Elastomer: NBR/Buna-N, optionally EPDM, FKM or special FKM (saturated steam-resistant) Pressure connection: brass, at DSP-W polyamide, optionally stainless steel or PVDF		

**5 ... 20 mbar / 12 bar**  
**-5 ... -20 / -700 mbar**

Switches



12

Dimensions		Overpressure protection	hysteresis max.	Measurement range	Order number
B	Ø	< bar	mbar / bar	mbar / bar	
mm	mm				D*

Pressure switch G <sup>1</sup> / <sub>4</sub> male, for low pressure			wetted sections: brass and NBR/Buna-N, scale toleranz 10%		DSP-D
68	45	0.5	3 mbar	5 ... 20 mbar	DSP-DB2
		0.5	5 mbar	10 ... 50 mbar	DSP-DB5
		0.5	10 mbar	25 ... 100 mbar	DSP-DC1
		1.0	20 mbar	50 ... 250 mbar	DSP-DC2
		1.0	50 mbar	100 ... 500 mbar	DSP-DC5
		10	150 mbar	0.25 ... 1.0 bar	DSP-D01
		10	250 mbar	0.5 ... 1.5 bar	DSP-D02
		10	500 mbar	1 ... 3.0 bar	DSP-D03
		25	0.5 / 2 bar*	1 ... 6.0 bar	DSP-D06
		25	0.5 / 2 bar*	4 ... 9.0 bar	DSP-D09
		25	0.5 / 2 bar*	7 ... 12 bar	DSP-D12



DSP-D09

Pressure switch G <sup>1</sup> / <sub>4</sub> male			wetted sections: brass and NBR/Buna-N, scale toleranz 10%		DSP-V
68	45	0.5	3 mbar	-5 ... - 20 mbar	DSP-V02
		0.5	5 mbar	-10 ... - 50 mbar	DSP-V05
		0.5	10 mbar	-25 ... -100 mbar	DSP-V10
		0.5	20 mbar	-50 ... -125 mbar	DSP-V12
		1.0	25 mbar	-75 ... -200 mbar	DSP-V20
		1.0	30 mbar	-100 ... -300 mbar	DSP-V30
		1.0	75 mbar	-200 ... -500 mbar	DSP-V50
		1.0	75 mbar	-300 ... -700 mbar	DSP-V70



DSP-W

Differential press. switch, nipple Ø 6.5			wetted sections: polyamide and NBR/Buna-N, scale toleranz 10%		DSP-W
77	45	0.1	3 mbar	5 ... 20 mbar	DSP-W20
		0.1	5 mbar	10 ... 50 mbar	DSP-W50



DSQ-KAP5

DSQ-KAP4

## Special options, add the appropriate letter

<b>factory-set pressure</b>		DSQ- . . .
<b>G<sup>1</sup>/<sub>8</sub> male</b>	pressure port thread, (not for DSP-W)	DSP- . . . 1
<b>stainless steel port</b>	pressure port thread, 1.4401, (not for DSP-W)	DSP- . . . S
<b>FKM elastomer</b>	max. 130 °C / 266 °F	DSP- . . . V
<b>EPDM elastomer</b>		DSP- . . . E
<b>increased overpressure</b>	max. 4 bar for pressure measurement range < 1 bar	DSP- . . . U
<b>gold contact</b>	max. 24 V AC, 100 mA	DSP- . . . G
<b>Ex-i-Atex</b>	II 1/2G Ex ia IIB T4 and II 1/2G Ex ia IIC T4	DSP- . . . EX
<b>Ex-ii-Atex</b>	II 1/2G Ex ia IIB T4 and II 1/2G Ex ia IIC T4	DSP- . . . SEX

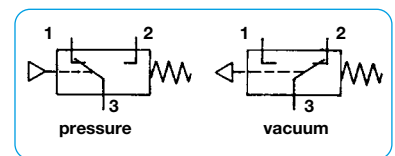

pin configuration

## Accessories, enclosed

<b>mounting bracket</b>	made of steel, including nut	for G <sup>1</sup> / <sub>4</sub>	<b>BW14-01</b>
<b>protection cap</b>	angular, cable feedthrough Ø 5 mm	IP44	<b>DS-KAP4</b>
	angular, high-strength cable gland Pg 9	IP54	<b>DS-KAP5</b>
		IP65	<b>DS-KAP6</b>

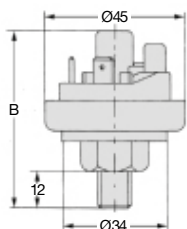

DSP/ DSQ

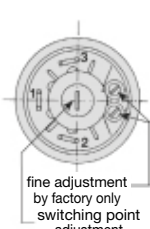

top view DS.

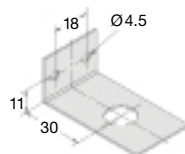

BW14-01

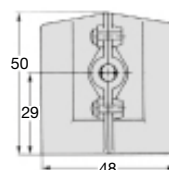

DS-KAP4

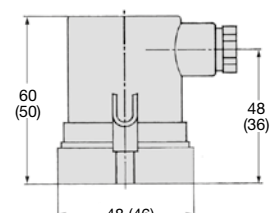

DS-KAP5 (-KAP6)

\* 0.5 bar at the beginning, 2 bar at the end of the pressure range

\* Product group





<b>Description</b>	High-precision pressure and vacuum switch with electrical outlet signal. The microswitch satisfies UL and CSA regulations. Polysulphone of the body approved by National Sanitation Foundation. The switch also complies with FDA regulations and is suitable for water and food products.		
<b>Media</b>	compressed air, non-corrosive gases or liquids		
<b>Switch contact</b>	micro SPDT switch, covered by plastic cap		
<b>Contact load</b>	3 A at 230 V AC or 1.2 A at 125 V DC 10 A at 230 V AC or 0.5 A at 125 V DC		
<b>Electrical connector</b>	0.187" (4.75 mm) quick connector for Molex connector		
<b>Repeatability</b>	± 2% FS		
<b>Certifications</b>	CSA-certified and UL-listed		
<b>Switching time</b>	25 ms		
<b>Mounting position</b>	any		
<b>Temperature range</b>	4 °C to 66 °C / 40 °F to 150 °F		
<b>Material</b>	Body: polysulphone	Spring: stainless steel	Media non-contact parts: nylon, carbon fibre nylon, acetal
	Diaphragm: polyurethane		

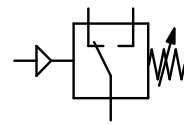

**3 ... 30 mbar / 7 bar**  
**-1 ... -10 mbar / -1 bar**

Description	Contact load	Hysteresis typical	Hysteresis max.	Over-pressure max. bar	Measurement range bar	Order number
	max. A	mbar	mbar	max. bar	bar	

Pressure and Vacuum Switch	pressure port 1/8" NPT male with nylon nipple Ø 1/16", and covering cap, SPDT switch	F4200				
pressure switch	3	3	10	1	0.003 ... 0.03	F4200- 0,5PT
	10	7	20	2	0.014 ... 0.14	F4200- 2PT
	10	30	50	2	0.035 ... 0.35	F4200- 5PT
	10	70	110	3	0.035 ... 1.0	F4200- 15PT
	10	120	160	4	0.035 ... 2.1	F4200- 30PT
	10	240	350	8	0.035 ... 4.2	F4200- 60PT
	10	400	500	8	0.070 ... 7.0	F4200-100PT
vacuum switch	3	1	3	-0.3	-0.001 ... -0.01	F4200-X 4PT
	10	17	27	-1	-0.007 ... -0.17	F4200-X 5PT
	10	34	50	-1	-0.015 ... -0.34	F4200-X10PT
	10	68	100	-1	-0.050 ... -1.00	F4200-X30PT



F4200-...PT



F4200-...FM



F4200-...PM



F4200-...MM

### Special options, add or change the appropriate letter

<b>flush mounting</b>	barbed fitting made of nylon, Ø 1/16", Ø 2 mm	F4200-...FM
<b>panel mounting</b>	barbed fitting made of nylon, Ø 1/16", Ø 2 mm	F4200-...PM
<b>manifold mounting</b>		F4200-...MM
<b>barbed fittings</b>	for FM and PM, made of nylon, Ø 1/16", Ø 2 mm	F4200-...B80 Stand.
	nylon, Ø 1/8", Ø 4 mm	F4200-...B85
	polysulphone, Ø 1/16", Ø 2 mm	F4200-...P80
	polysulphone, Ø 1/8", Ø 4 mm	F4200-...P85
<b>gold contact</b>		F4200-...1B
<b>factory-set switchpoint</b>	± 5%, indicate on order	F4200-...X
<b>free of oil and grease</b>	specially cleaned, suitable for oxygen	F4200-...L

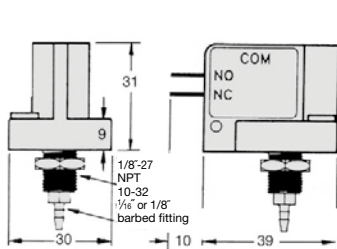

F4200 - PM

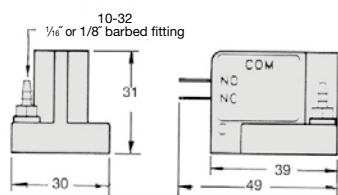

F4200 - FM

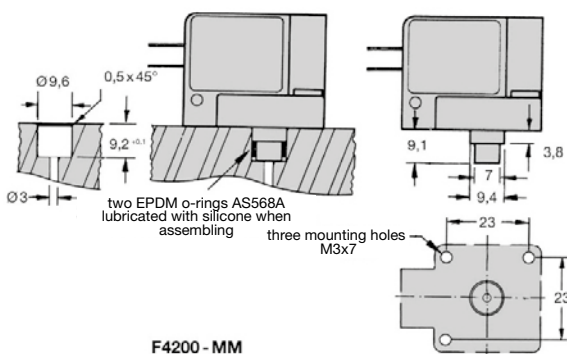

F4200 - MM

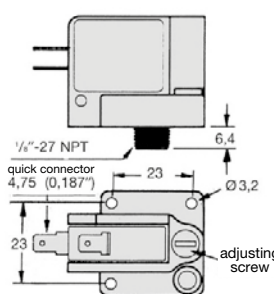

F4200 - PT

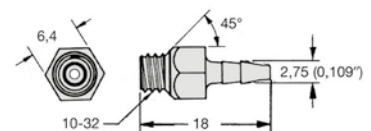

B80 / P80

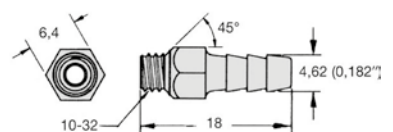

B85 / P85

\* Product group

PDF CAD  
www.aircom.net



Order example:  
F4200-0,5PT

# PRESSURE AND VACUUM SWITCH WITH LOW HYSTERESIS, TYPE "AIRROL®"

F4300

<b>Description</b>	Pressure and vacuum switch with electrical outlet signal and low hysteresis. The microswitch satisfies UL and CSA regulations. Polysulphone of the body approved by National Sanitation Foundation. The switch also complies with FDA regulations and is suitable for water and food products.		
<b>Media</b>	compressed air, non-corrosive gases or liquids		
<b>Switch contact</b>	micro SPDT switch, covered by plastic cap		
<b>Contact load</b>	3 A or 4 A at 230 V AC, see chart		
<b>Electrical connector</b>	0.110" (2.8 mm) quick connector for Molex/ETC connector		
<b>Repeatability</b>	± 2% FS		
<b>Certifications</b>	CSA-certified and UL-listed		
<b>Switching time</b>	25 ms		
<b>Mounting position</b>	any		
<b>Temperature range</b>	4 °C to 66 °C / 40 °F to 150 °F		
<b>Material</b>	Body: polysulphone	Spring: stainless steel	
	Diaphragm: polyurethane	Media non-contact parts: nylon, carbon fibre nylon, acetal	

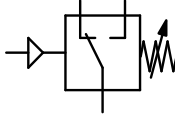

**14 ... 140 mbar / 7 bar**  
**-7 ... -170 mbar / -1 bar**

Switches  
12

Description	Contact load	Hysteresis typical	Hysteresis max.	Over-pressure max. bar	Measurement range bar	Order number
	max. A	mbar	mbar	max. bar	bar	

Pressure / vacuum switch, low hysteresis	Contact load	Hysteresis typical	Hysteresis max.	Over-pressure max. bar	Measurement range bar	Order number
pressure switch	3	7	14	2	0.014 ... 0.14	F4300- 2PT
	4	14	24	2	0.035 ... 0.35	F4300- 5PT
	4	30	41	3	0.035 ... 1.0	F4300- 15PT
	4	40	70	4	0.035 ... 2.1	F4300- 30PT
	4	100	170	8	0.035 ... 4.2	F4300- 60PT
	4	140	240	8	0.070 ... 7.0	F4300-100PT
vacuum switch	4	10	20	-1	-0.007 ... -0.17	F4300-X 5PT
	4	20	34	-1	-0.015 ... -0.34	F4300-X10PT
	4	34	50	-1	-0.050 ... -1.00	F4300-X30PT



## Special options, add or change the appropriate letter

- flush mounting** barbed fitting made of nylon, Ø 1/16", Ø 2 mm F4300-...FM
- panel mounting** barbed fitting made of nylon, Ø 1/16", Ø 2 mm F4300-...PM
- manifold mounting** F4300-...MM
- barbed fittings** for FM and PM, made of nylon, Ø 1/16", Ø 2 mm F4300-...B80 Stand.
- nylon, Ø 1/8", Ø 4 mm F4300-...B85
- polysulphone, Ø 1/16", Ø 2 mm F4300-...P80
- polysulphone, Ø 1/8", Ø 4 mm F4300-...P85
- 0.1 A at 125 V AC F4300-...1B
- gold contact** F4300-...X
- factory-set switchpoint** ± 5%, indicate on order F4300-...L
- free of oil and grease** specially cleaned, suitable for oxygen

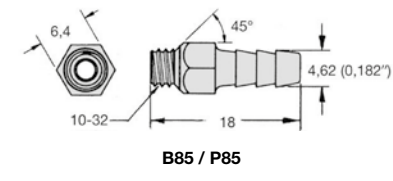
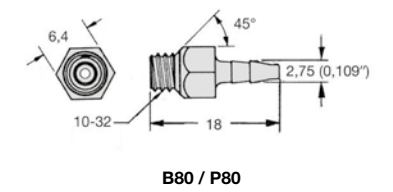
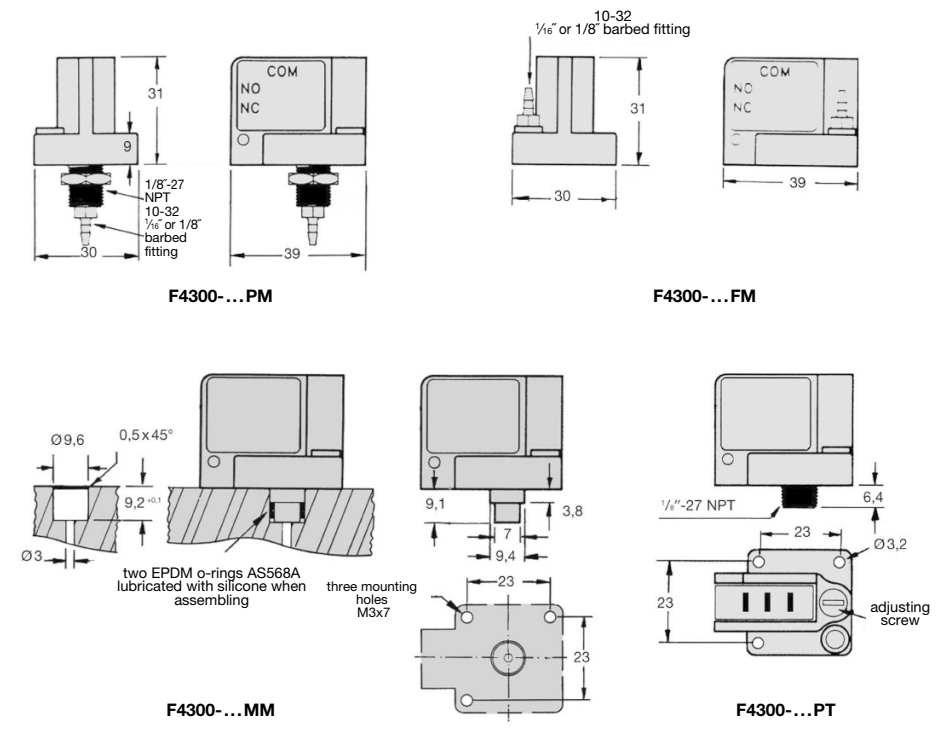

\* Product group

<b>Description</b>	Pilot-actuated pressure valve with precisely adjustable pilot setpoint. Perfect for applications which require intrinsic safety, pneumatic sequencing or pressure relief. Valves are normally opened or closed. The switch complies with FDA regulations and is suitable for water and food products.	
<b>Media</b>	5 µm filtered compressed air	
<b>Pressure valve</b>	3-port/2-way air-assisted servo valve with exhaust to atmosphere, NO or NC, made of nylon	
	Supply pressure:	1.4...8 bar, untapped exhaust
	Air consumption:	max. 0.3 l/min at 2 bar supply pressure or max. 0.7 l/min at 7 bar
	Pneumatic connection:	quick connector for hose external diameter of 4 mm (5/32")
	Flow rate:	70 l/min at 7 bar, nominal size DN 0.2, K <sub>v</sub> = 0.05
	Switching time:	64 ms at 6 bar supply pressure
<b>Accuracy</b>	Pressure switch:	at supply pressure variation of 0.7 bar: < 7 mbar pressure deviation
	Vacuum switch:	at supply pressure variation of 0.3 bar: < 3 mbar pressure deviation
	Repeatability:	± 2% FS
<b>Temperature range</b>	4 °C to 60 °C / 40 °F to 140 °F	
<b>Material</b>	Body:	polysulphone
	Diaphragm:	polyurethane
	<b>Mounting position</b>	any
	Spring:	stainless steel
	Media non-contact parts:	nylon, carbon fibre nylon, acetal

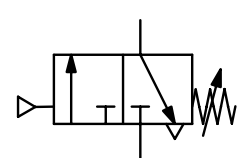

**70 ... 350 mbar / 7 bar**  
**-30 ... -170 / -850 mbar**

Switches  
12

Description	Supply pressure of switching valve	Hysteresis typical	Hysteresis max.	Over-pressure max. bar	Measurement range bar	Order number
-------------	------------------------------------	--------------------	-----------------	------------------------	-----------------------	--------------

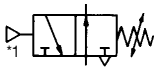
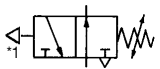
Switch with pneumatic output, NO	1/8" NPT male, supply pressure 1.4...8 bar		PP / VP700			
 pressure switch	1.4 ... 8 bar	15	30	2	0.07 ... 0.35	<b>PP700- 5PT</b>
			20	4	0.07 ... 1.0	<b>PP700- 15PT</b>
	NO	20	70	4	0.07 ... 2.1	<b>PP700- 30PT</b>
		35	140	8	0.20 ... 4.2	<b>PP700- 60PT</b>
		50	240	8	0.35 ... 7.0	<b>PP700-100PT</b>
 vacuum switch	1.4 ... 8 bar	15	35	-1	-0.03 ... -0.17	<b>VP700- 5PT</b>
		20	40	-1	-0.03 ... -0.34	<b>VP700- 10PT</b>
	NO	35	70	-1	-0.07 ... -0.85	<b>VP700- 30PT</b>

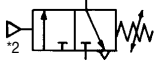
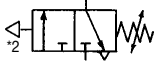

PP/VP700-...PT

Switch with pneumatic output, NC	1/8" NPT male, supply pressure 1.4...8 bar		PP / VP701			
 pressure switch	1.4 ... 8 bar	15	30	2	0.07 ... 0.35	<b>PP701- 5PT</b>
			20	4	0.07 ... 1.0	<b>PP701- 15PT</b>
	NC	20	70	4	0.07 ... 2.1	<b>PP701- 30PT</b>
		35	140	8	0.20 ... 4.2	<b>PP701- 60PT</b>
		50	240	8	0.35 ... 7.0	<b>PP701-100PT</b>
 vacuum switch	1.4 ... 8 bar	15	35	-1	-0.03 ... -0.17	<b>VP701- 5PT</b>
		20	40	-1	-0.03 ... -0.34	<b>VP701- 10PT</b>
	NC	35	70	-1	-0.07 ... -0.85	<b>VP701- 30PT</b>



PP/VP701-...FM

**Special options, add or change the appropriate letter**

<b>flush mounting</b>	barbed fitting made of nylon,	Ø 1/16", Ø 2 mm	.P70-... <b>FM</b>
<b>panel mounting</b>	barbed fitting made of nylon,	Ø 1/16", Ø 2 mm	.P70-... <b>PM</b>
<b>manifold mounting</b>			.P70-... <b>MM</b>
<b>barbed fitting</b>	for FM and PM,	nylon, Ø 1/16", Ø 2 mm	.P70-... <b>B80 Stand.</b>
		nylon, Ø 1/8", Ø 4 mm	.P70-... <b>B85</b>
		polysulphone, Ø 1/16", Ø 2 mm	.P70-... <b>P80</b>
		polysulphone, Ø 1/8", Ø 4 mm	.P70-... <b>P85</b>
<b>free of grease and oil</b>	especially cleaned, suitable for oxygen		.P70-... <b>L</b>

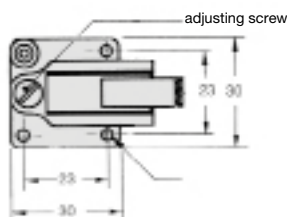

PP / VP70

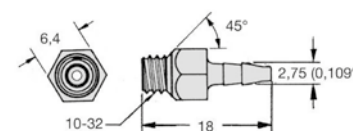
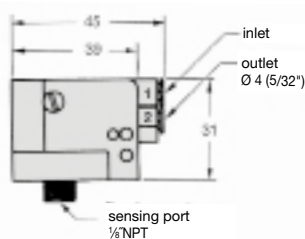

B80 / P80

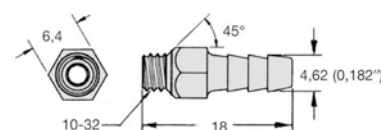

B85 / P85

\*1 only output signal in the absence of input signal (positive pressure, vacuum)  
\*2 no output signal in the absence of input signal (positive pressure, vacuum)

\* Product group

PDF CAD  
www.aircom.net



Order example:  
PP700-5PT